

Y-Bearing Flanged Units With Oval Grey Cast Iron Housing "N"

UEN 209 2S

Y-Bearing Flanged Units With Oval Grey Cast Iron Housing "N"

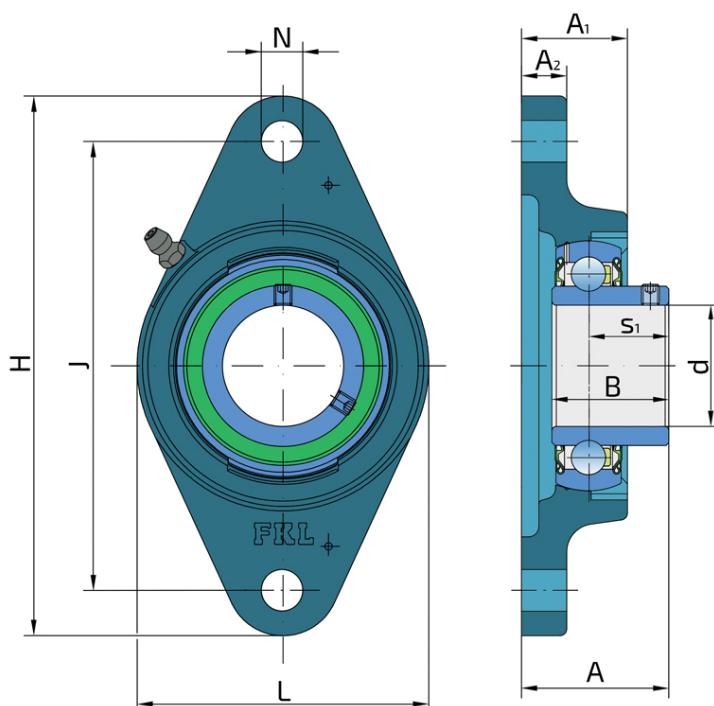
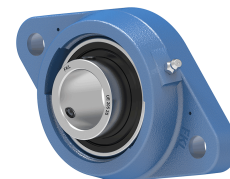

Technical Specification

d	Bore diameter	45 mm
L	Overall width	108 mm
A	Distance from the housing flange to the front of the inner ring of the bearing	47.8 mm
A1	Total housing width	38 mm
A2	Housing flange thickness	18 mm
H	Housing height	188 mm
J	Pitch circle diameter	148 mm
N	Diameter of attachment slot	19 mm
kg	Mass	1.73 kg
Cdyn	Dynamic load rating	33.2 kN
Co	Static load rating	21.6 kN
Pu	Fatigue load limit	0.915 kN

Sealing

S SEAL / S SEAL (2S)

Single lip seal with the labyrinth between the sheet part and the rubber lip which conducts the contact sealing. The friction and speeds are the same as with RS but provides much better protection against the rough impurity particles. This is very good sealing system: the sheet part protects the seal from the soil, dust and rough particles. At the same time makes the labyrinth with the rubber part. The rubber part provides contact sealing which prevents penetration of finer impurities, water, moisture, steam etc. Suitable for neutral conditions because of the presence of the foreign materials. It is used with the Y bearing (standard) and deep groove ball bearings.

