

# Y-Ball Bearings With Eccentric Locking Collar

## LY 209 2F.SH

Y-Ball Bearings With Eccentric Locking Collar

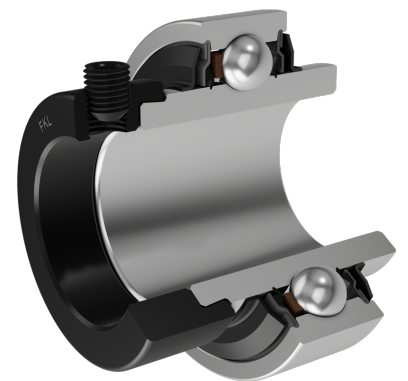
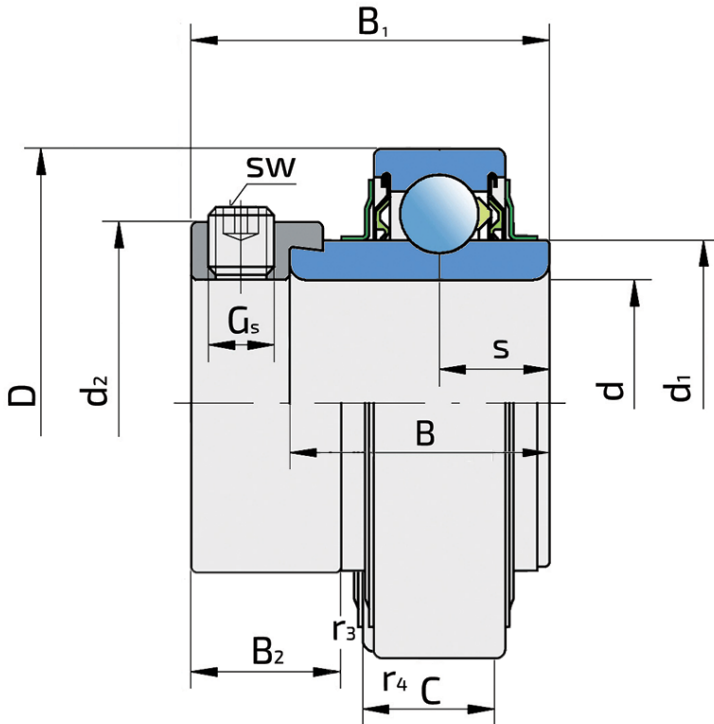

### Technical Specification

d	Bore diameter	45 mm
D	Outside diameter	85 mm
B	Width inner ring	42.8 mm
C	Width outer ring	22 mm
s	Distance from inner ring side face to raceway centre	21.4 mm
d1	Outer diameter inner ring	56.6 mm
E	Distance from raceway centre to the hole for lubrication	6.1 mm
Gs	Set screw	M10x2 mm
sw	Hexagonal key size for set screw	5 mm
r1,2	Inner ring Chamfer dimension	1 mm
r3,4	Outside ring Chamfer dimension	1.5 mm
B1	Width inner ring with locking collar	56.3 mm
d2	Locking collar outside diameter	63.6 mm
B2	Width locking collar	18.3 mm
Cdyn	Dynamic load rating	33.2 kN
Co	Static load rating	21.6 kN
Pu	Fatigue load limit	0.92 kN
kg	Mass	0.76 kg

## Sealing

---

### F SEAL / F SEAL (2F)

Dual sealing, protection cover placed on the inner ring protects against rough impurity particles and makes the labyrinth with the sheet part of the seal; then the sealing S type,

with the labyrinth between the sheet part and the rubber lip that conducts the contact sealing. The friction and speeds are the same as with S but has much better protection

against rough impurity particles. It is very good sealing system: the sheet part protects the seal from the soil, dust and

rough particles. At the same time makes the labyrinth with the rubber part. The rubber part provides the contact sealing that prevents the penetration of the finer impurities, water, moisture, steam etc. Suitable for heavier conditions due to better protection against foreign matters. It is used with the Y bearings (standard).

